

# Power Supply

## FP-1030A

### Technical Supplement

©2003 VERTEX STANDARD CO., LTD. Printed in Japan.

**VERTEX STANDARD CO., LTD.**  
4-8-8 Nakameguro, Meguro-Ku, Tokyo 153-8644, Japan

**VERTEX STANDARD**  
**US Headquarters**  
10900 Walker Street, Cypress, CA 90630, U.S.A.

**YAESU EUROPE B.V.**  
P.O. Box 75525, 1118 ZN Schiphol, The Netherlands

**YAESU UK LTD.**  
Unit 12, Sun Valley Business Park, Winnall Close  
Winchester, Hampshire, SO23 0LB, U.K.

**VERTEX STANDARD HK LTD.**  
Unit 5, 20/F., Seaview Centre, 139-141 Hoi Bun Road,  
Kwun Tong, Kowloon, Hong Kong

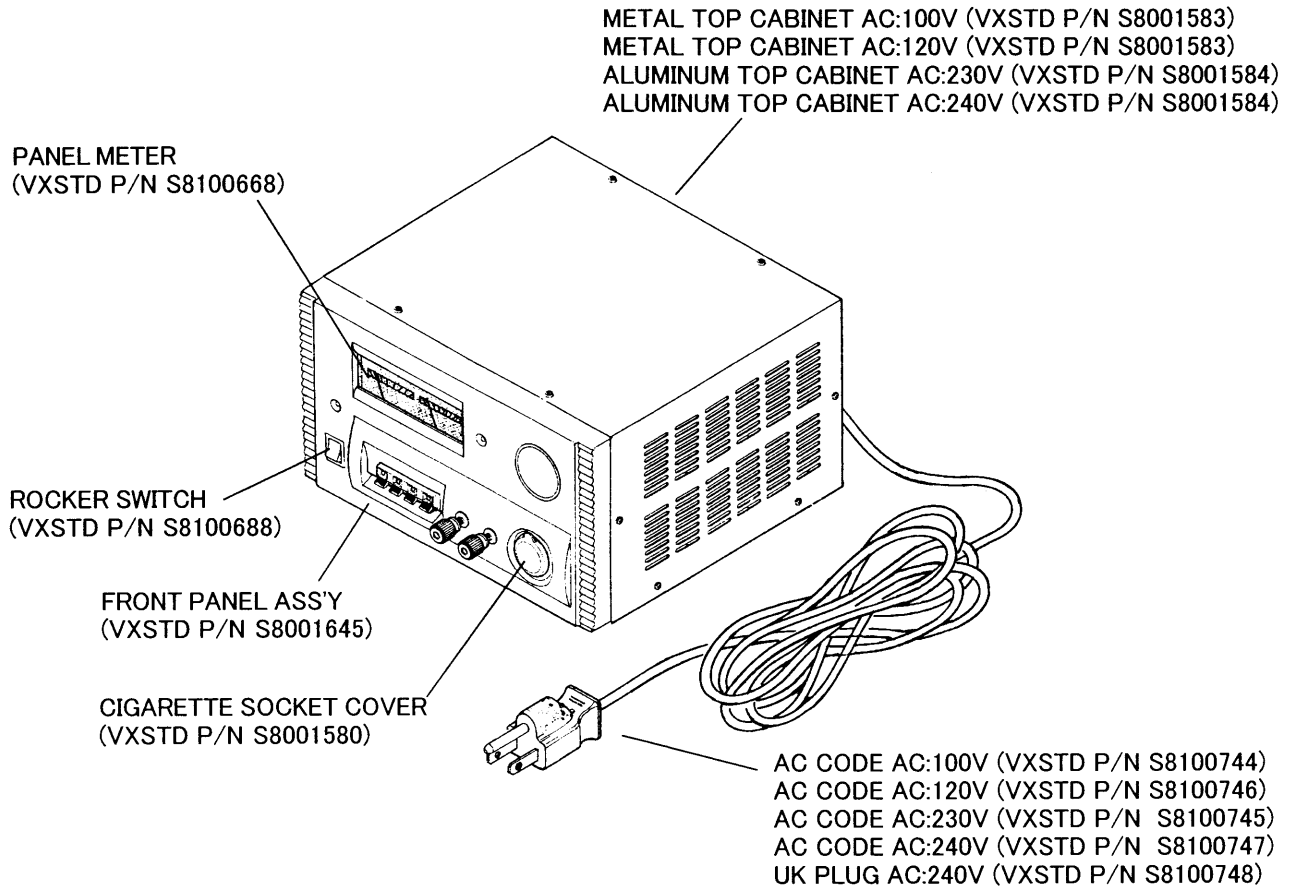

## Specifications

VOLTAGE TYPE	AC 120V	AC 230V	AC 240V
RATED VOLTAGE RANGE	±7%		
OUTPUT VOLTAGE	13.8V DC (FIXED)		
OUTPUT CURRENT	25 A CONTINUOUS		
OVERLOAD PROTECTION	27 A		
RIPPLE VOLTAGE	BETTER THAN 3mVp-p AT 13.8V, 25 A		
COOLING SYSTEM	THERMOSTATICALLY-CONTROLLED COOLING FAN		
CIRCUIT TYPE	LINEAR SERIES		
AC INPUT FUSE	8 A	5 A	
WEIGHT	9.5 kg (20.9 LBS)		
DIMENSIONS:	250 (W) × 150 (H) × 240 (D) mm (9.8" × 5.9" × 9.5")		



# Circuit Diagram

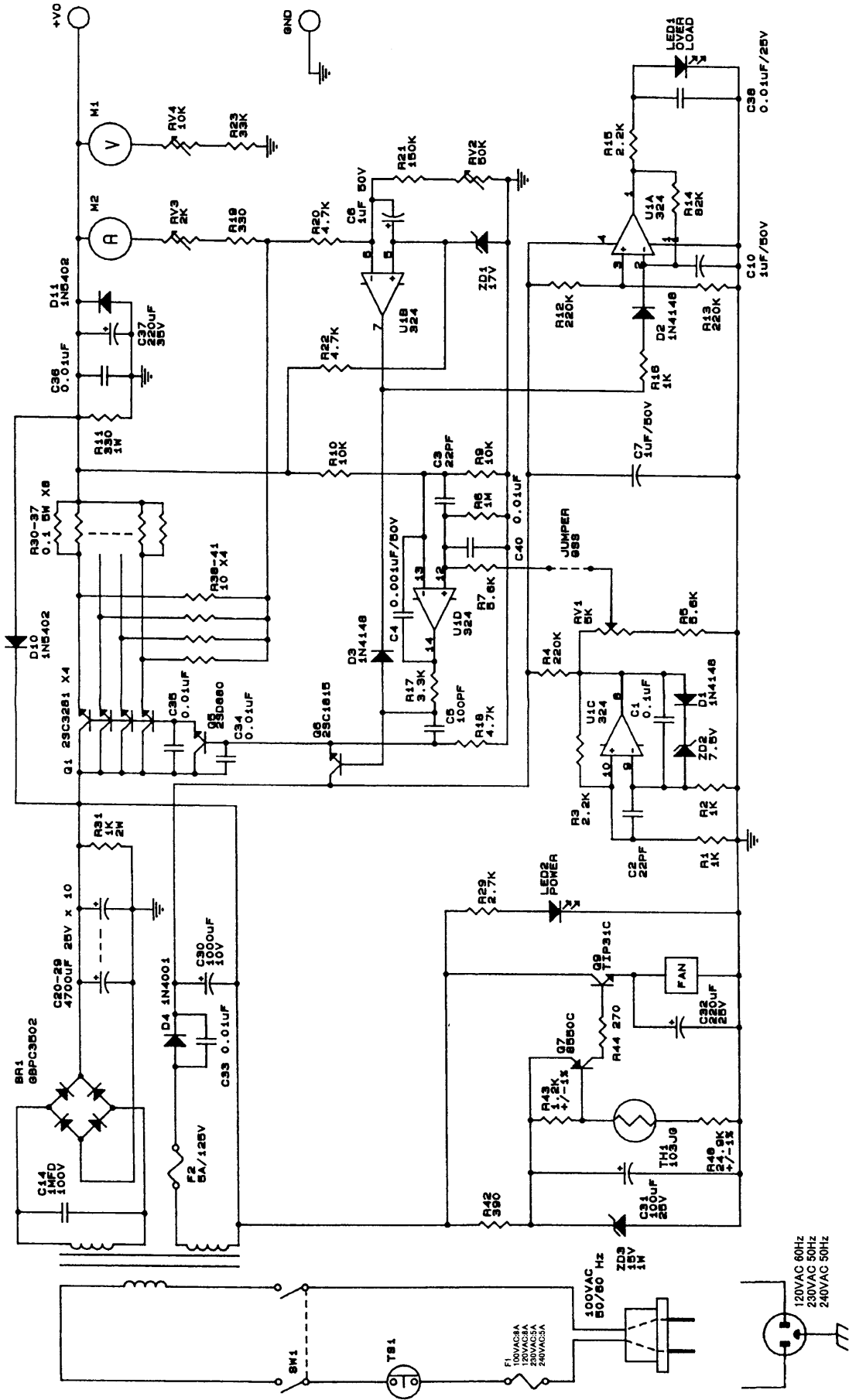

NOTE : ALL RESISTORS ARE IN OHM AND 1/4W EXCEPT SPECIFIED

120VAC 60HZ  
250VAC 50HZ  
240VAC 50HZ

# Parts Layout

## CNTL-Unit

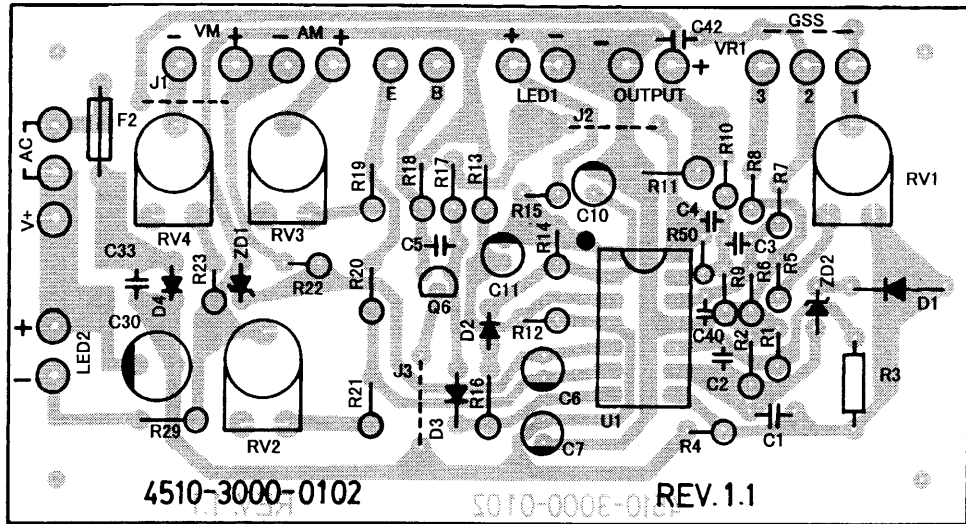

Component side

## Capacitor-Unit

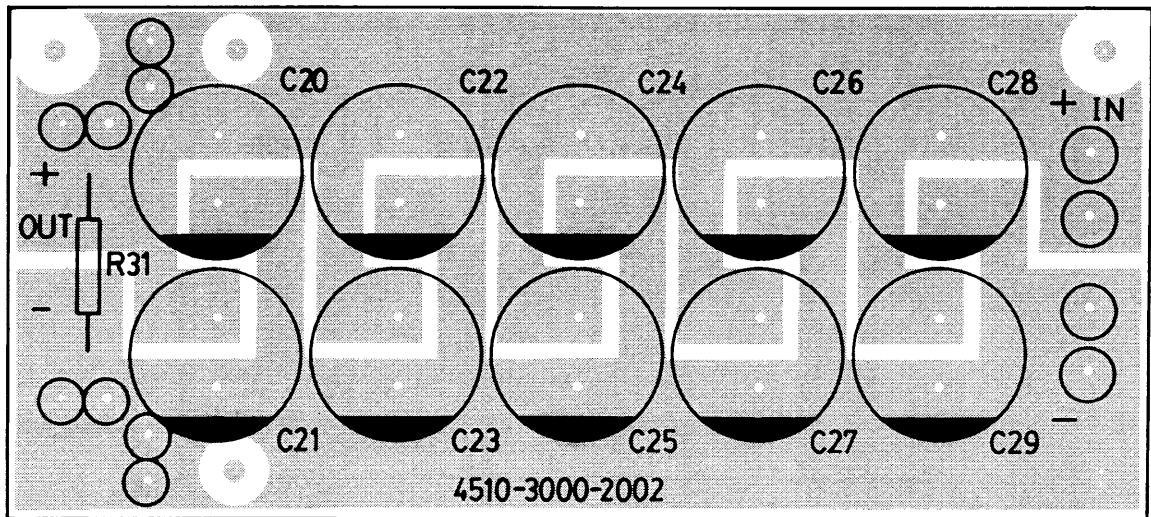

Component side

### AUX1-Unit

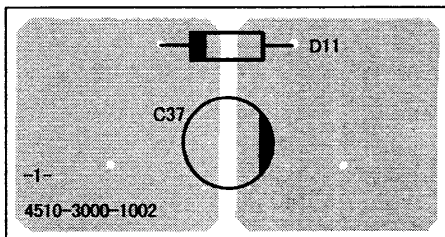

Component side

### AUX2-Unit

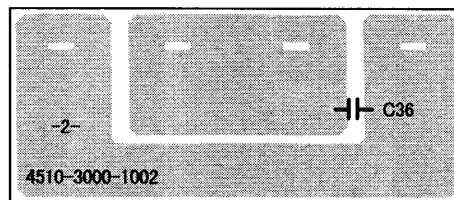

Component side

### AUX4-Unit

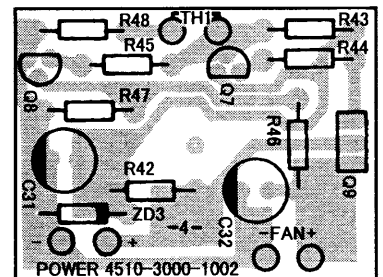

Component side

### AUX5-Unit

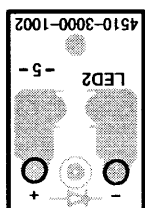

Component side

### AUX6-Unit

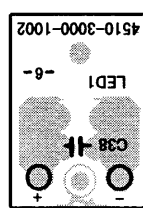

Component side

AUX10-Unit

AUX7-Unit

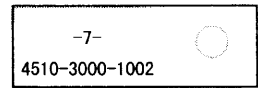

Component side

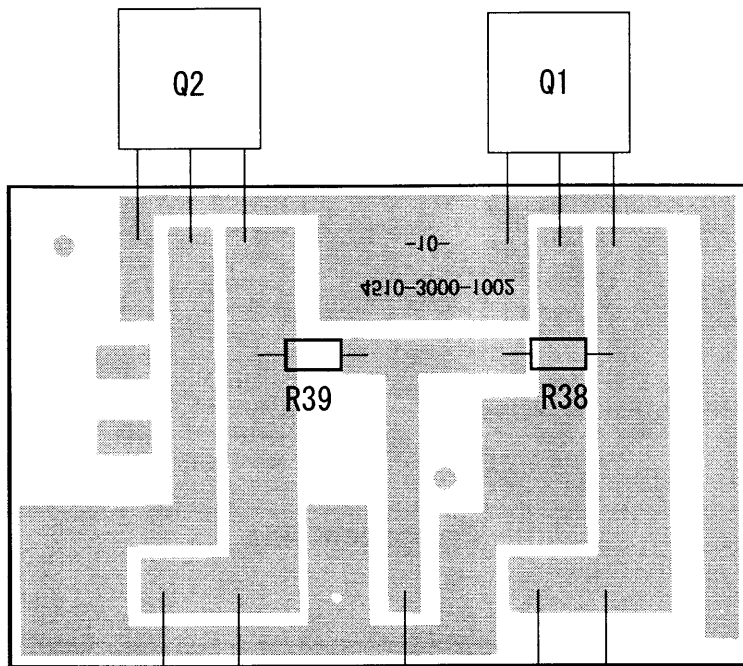

Solder side

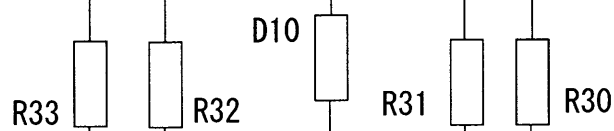

AUX9-Unit

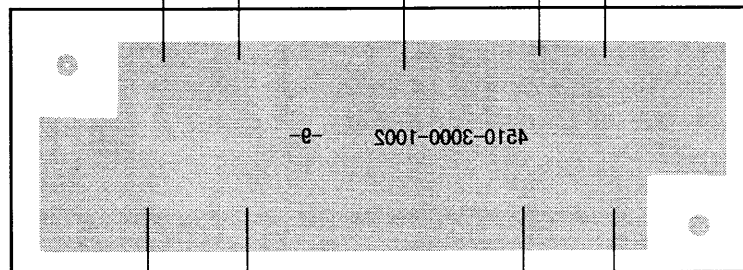

Solder side



AUX8-Unit

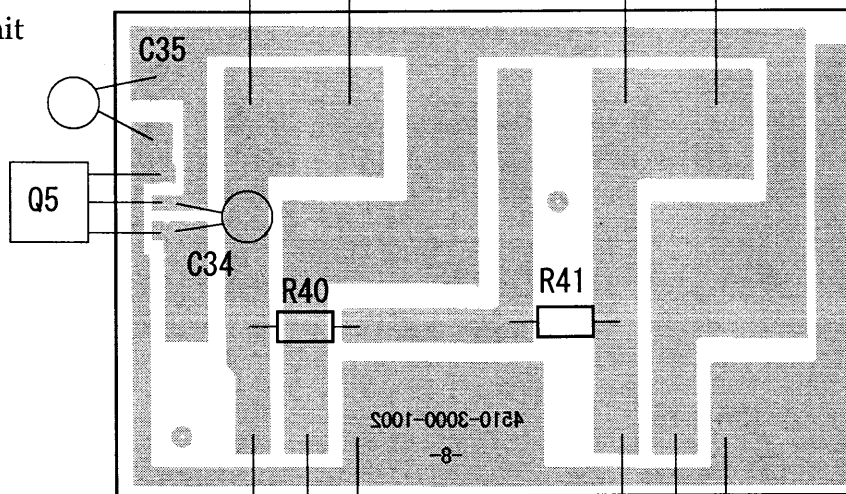

Solder side

# Parts List

REF.	DESCRIPTION	VALUE	V/W	TOL.	MFR'S DESIG	VXSTD P/N	VERS.	LOT.
*** CNTL UNIT ***								
	Printed Circuit Board				4510-3000-0102	-		1-
C 0001	CERAMIC CAP.	0.0047uF	50V	B	CK45B1H472MYS	K10179025		1-
C 0002	CERAMIC CAP.	22pF	50V	SL	UP050SL220J-A-B	K28179035		1-
C 0003	CERAMIC CAP.	22pF	50V	SL	UP050SL220J-A-B	K28179035		1-
C 0004	CERAMIC CAP.	0.001uF	50V	B	DD104B102K50	K10176102		1-
C 0005	CERAMIC CAP.	100pF	50V	B	DD104B101K50	K10176101		1-
C 0006	AL.ELECTRO.CAP.	1uF	50V		50V010M5X11TR5	K46170017		1-
C 0007	AL.ELECTRO.CAP.	1uF	50V		50V010M5X11TR5	K46170017		1-
C 0010	AL.ELECTRO.CAP.	1uF	50V		50V010M5X11TR5	K46170017		1-
C 0030	AL.ELECTRO.CAP.	1000uF	10V		RE2-10V102MM 1000UF	K40109012		1-
C 0033	CERAMIC CAP.	0.01uF	50V	B	DD112B103K50	K10179052		1-
C 0040	CERAMIC CAP.	0.01uF	50V	B	DD112B103K50	K10179052		1-
D 0001	DIODE				1N4148 TNR	S8100709		1-
D 0002	DIODE				1N4148 TNR	S8100709		1-
D 0003	DIODE				1N4148 TNR	S8100709		1-
D 0004	RECTIFIER DIODE				1N4001	S8100710		1-
F 0002	FUSE	5A	125V		TCM22NM 5A125V	S8100739		1-
J 0001	JUMPER WIRE				4751-0109-3022	S8100737		1-
J 0002	JUMPER WIRE				4751-0109-3022	S8100737		1-
J 0003	JUMPER WIRE				4751-0109-3022	S8100737		1-
Q 0006	TRANSISTOR				2SC1815-GR	G3318150G		1-
R 0001	CARBON FILM RES.	1kohm	1/4W	5%	RD14TJ102 1K	J01245102		1-
R 0002	CARBON FILM RES.	1kohm	1/4W	5%	RD14TJ102 1K	J01245102		1-
R 0003	CARBON FILM RES.	2.2kohm	1/4W	5%	RD14TJ222 2.2K	J01245222		1-
R 0004	CARBON FILM RES.	220kohm	1/4W	5%	RD14TJ224 220K	J01245224		1-
R 0005	CARBON FILM RES.	5.6kohm	1/4W	5%	RD14TJ562 5.6K	J01245562		1-
R 0006	CARBON FILM RES.	1Mohm	1/4W	5%	RD14TJ105 1M	J01245105		1-
R 0007	CARBON FILM RES.	5.6kohm	1/4W	5%	RD14TJ562 5.6K	J01245562		1-
R 0009	CARBON FILM RES.	10kohm	1/4W	5%	RD14TJ103 10K	J01245103		1-
R 0010	CARBON FILM RES.	10kohm	1/4W	5%	RD14TJ103 10K	J01245103		1-
R 0011	CARBON FILM RES.	330ohm	1W	5%	1W 330OHM +-5%	S8100691		1-
R 0012	CARBON FILM RES.	220kohm	1/4W	5%	RD14TJ224 220K	J01245224		1-
R 0013	CARBON FILM RES.	220kohm	1/4W	5%	RD14TJ224 220K	J01245224		1-
R 0014	CARBON FILM RES.	82kohm	1/4W	5%	RD14TJ823 82K	J01245823		1-
R 0015	CARBON FILM RES.	2.2kohm	1/4W	5%	RD14TJ222 2.2K	J01245222		1-
R 0016	CARBON FILM RES.	1kohm	1/4W	5%	RD14TJ102 1K	J01245102		1-
R 0017	CARBON FILM RES.	3.3kohm	1/4W	5%	RD14TJ332 3.3K	J01245332		1-
R 0018	CARBON FILM RES.	4.7kohm	1/4W	5%	RD14TJ472 4.7K	J01245472		1-
R 0019	CARBON FILM RES.	330ohm	1/4W	5%	RD14TJ331 330	J01245331		1-
R 0020	CARBON FILM RES.	4.7kohm	1/4W	5%	RD14TJ472 4.7K	J01245472		1-
R 0021	CARBON FILM RES.	150kohm	1/4W	5%	RD14TJ154 150K	J01245154		1-
R 0022	CARBON FILM RES.	4.7kohm	1/4W	5%	RD14TJ472 4.7K	J01245472		1-
R 0023	CARBON FILM RES.	33kohm	1/4W	5%	RD14TJ333 33K	J01245333		1-
R 0029	CARBON FILM RES.	2.7kohm	1/4W	5%	RD14TJ272 2.7K	J01245272		1-
RV0001	SEMI VAR. RES.	5kohm		B	B5K FRM-085	S8100697		1-
RV0002	SEMI VAR. RES.	50kohm		B	B50K FRM-085	S8100698		1-
RV0003	SEMI VAR. RES.	2kohm		B	B2K FRM-085	S8100696		1-
RV0004	SEMI VAR. RES.	10kohm		B	B10K FRM-085	S8100695		1-
U 0001	IC				LM324N	G1090425		1-
ZD0001	ZENER DIODE	17V	1/2W			S8100713		1-
ZD0002	ZENER DIODE				MTZJ7.5C TNR	S8100714		1-
*** AUX-1 UNIT ***								
	Printed Circuit Board				4510-3000-1002 -1-	-		1-
C 0037	AL.ELECTRO.CAP.	220uF	25V		25V221M8X11TR5	K46140006		1-
D 0011	RECTIFIER DIODE				1N5001	S8100711		1-
*** AUX-2 UNIT ***								
	Printed Circuit Board				4510-3000-1002 -2-	-		1-
C 0036	CERAMIC CAP.	0.01uF	50V	B	DD112B103K50	K10179052		1-

REF.	DESCRIPTION	VALUE	V/W	TOL.	MFR'S DESIG	VXSTD P/N	VERS.	LOT.
		*** AUX-4 UNIT ***						
C 0031	Printed Circuit Board ALELECTRO.CAP.	100uF	25V		4510-3000-1002 -4- 25V101M6X11TR5	- K46140005		1-
C 0032	ALELECTRO.CAP.	220uF	25V		25V221M8X11TR5	K46140006		1-
Q 0007	TRANSISTOR				8550C	S8100707		1-
Q 0009	TRANSISTOR				TIP31C TO-220	S8100708		1-
R 0042	CARBON FILM RES.	390ohm	1/4W	5%	RD14TJ391 390	J01245391		1-
R 0043	METAL FILM RES.	1.2kohm	1/4W	1%	1/4W 1.2KOHM +-1%	S8100693		1-
R 0044	CARBON FILM RES.	270kohm	1/4W	5%	RD14TJ274 270K	J01245274		1-
R 0048	METAL FILM RES.	24.9ohm	1/4W	1%	1/4W 24.9OHM 1%	S8100694		1-
ZD0003	ZENER DIODE				15V1WTNR	S8100712		1-
	THERMISTOR				PG-103JG 10K	S8100664		1-
		*** AUX-5 UNIT ***						
Q 0001	Printed Circuit Board LED				4510-3000-1002 -5- EL204GD(GREEN)	- S8100667		1-
		*** AUX-6 UNIT ***						
C 0038	Printed Circuit Board CERAMIC CAP.	0.01uF	50V	F	4510-3000-1002 -6- DD106F103Z50	- K13179008		1-
Q 0001	LED				EL204HD(RED)	S8100666		1-
		*** AUX-7 UNIT ***						
	Printed Circuit Board				4510-3000-1002 -7-	-		1-
		*** AUX-8 UNIT ***						
C 0034	Printed Circuit Board CERAMIC CAP.	0.01uF	50V	F	4510-3000-1002 -8- DD106F103Z50	- K13179008		1-
C 0035	CERAMIC CAP.	0.01uF	50V	F	DD106F103Z50	K13179008		1-
Q 0003	TRANSISTOR				2SD1957S	S8100661		1-
Q 0004	TRANSISTOR				2SD1957S	S8100661		1-
Q 0005	TRANSISTOR				2SD880-Y	G3408800Y		1-
R 0040	CARBON FILM RES.	10ohm	1/4W	5%	RD14TJ100 10	J01245100		1-
R 0041	CARBON FILM RES.	10ohm	1/4W	5%	RD14TJ100 10	J01245100		1-
		*** AUX-9 UNIT ***						
D 0010	Printed Circuit Board RECTIFIER DIODE				4510-3000-1002 -9- 1N5401	- S8100662		1-
R 0030	CEMENT RES.	0.1ohm	5W	5%	ERF-5AJ0R1	J30375019		1-
R 0031	CEMENT RES.	0.1ohm	5W	5%	ERF-5AJ0R1	J30375019		1-
R 0032	CEMENT RES.	0.1ohm	5W	5%	ERF-5AJ0R1	J30375019		1-
R 0033	CEMENT RES.	0.1ohm	5W	5%	ERF-5AJ0R1	J30375019		1-
R 0034	CEMENT RES.	0.1ohm	5W	5%	ERF-5AJ0R1	J30375019		1-
R 0035	CEMENT RES.	0.1ohm	5W	5%	ERF-5AJ0R1	J30375019		1-
R 0036	CEMENT RES.	0.1ohm	5W	5%	ERF-5AJ0R1	J30375019		1-
R 0037	CEMENT RES.	0.1ohm	5W	5%	ERF-5AJ0R1	J30375019		1-
		*** AUX-10 UNIT ***						
Q 0001	Printed Circuit Board TRANSISTOR				4510-3000-1002 -10- 2SD1957S	- S8100661		1-
Q 0002	TRANSISTOR				2SD1957S	S8100661		1-
R 0038	CARBON FILM RES.	10ohm	1/4W	5%	RD14TJ100 10	J01245100		1-
R 0039	CARBON FILM RES.	10ohm	1/4W	5%	RD14TJ100 10	J01245100		1-
		*** CAPACITOR UNIT ***						
C 0020	Printed Circuit Board ALELECTRO.CAP.	4700uF	35V		4510-3000-2002 RPK-35V472MS 4700UF	- K40169024		1-
C 0021	ALELECTRO.CAP.	4700uF	35V		RPK-35V472MS 4700UF	K40169024		1-
C 0022	ALELECTRO.CAP.	4700uF	35V		RPK-35V472MS 4700UF	K40169024		1-
C 0023	ALELECTRO.CAP.	4700uF	35V		RPK-35V472MS 4700UF	K40169024		1-
C 0024	ALELECTRO.CAP.	4700uF	35V		RPK-35V472MS 4700UF	K40169024		1-
C 0025	ALELECTRO.CAP.	4700uF	35V		RPK-35V472MS 4700UF	K40169024		1-
C 0026	ALELECTRO.CAP.	4700uF	35V		RPK-35V472MS 4700UF	K40169024		1-
C 0027	ALELECTRO.CAP.	4700uF	35V		RPK-35V472MS 4700UF	K40169024		1-
C 0028	ALELECTRO.CAP.	4700uF	35V		RPK-35V472MS 4700UF	K40169024		1-
C 0029	ALELECTRO.CAP.	4700uF	35V		RPK-35V472MS 4700UF	K40169024		1-

REF.	DESCRIPTION	VALUE	V/W	TOL.	MFR'S DESIG	VXSTD P/N	VERS.	LOT.
R 0032	CARBON FILM RES.	1kohm	2W	5%	2W 1KOHM +-5%	S8100692		1-
		*** MAIN ASSY ***						
	BRIDGE DIODE	8A	250V		GBPC3502	S8100663		1-
	FUSE	8A	250V		8A250V 20M/M	S8100665	AC:100V	1-
	FUSE				8A250V 20M/M	S8100665	AC:120V	1-
	FUSE	5A			5A MF-51	Q0000027	AC:230V	1-
	FUSE	5A			5A MF-51	Q0000027	AC:240V	1-
	DC FAN				KD1208PTS1-6	S8100690		1-
	ROCKER SWITCH				M372-399-1R2 1PIT	S8100688		1-
	TRANS.				GSV-3000-TR011	S8100658	AC:100V	1-
	TRANS.				GSV-3000-TR527	S8100659	AC:120V	1-
	TRANS.				GSV-3000-TR002	S8100655	AC:230V	1-
	TRANS.				GSV-3000-TR040	S8100660	AC:240V	1-
	THERMISTOR				NT-101NA	S8100738		1-
	AC CODE				4610-2000-9328	S8100744	AC:100V	1-
	AC CODE				4610-1720-5030	S8100746	AC:120V	1-
	AC CODE				4610-2000-7238	S8100745	AC:230V	1-
	AC CODE				4690-3000-7232	S8100747	AC:240V	1-
	UK PLUG	13A	250V		BLACK	S8100748	AC:240V	1-
	TERMINAL				SPT-004	S8001578		1-
	TERMINAL (2pcs)				SL5.5-5 (F/FP1030A)	S8001594		1-
	CONNECTOR				7021-0000-0805	S8100689		1-
	PANEL METER				DE-2895	S8100668		1-
	CIGARETTE SOCKET COVER				FP1030A	S8001580		1-
	HEAT SINK (2pcs)				FP1030A	S8001581		1-
	FRAME				FP1030A	S8001582		1-
	METAL TOP CABINET				FP1030A	S8001583	AC:100V	1-
	METAL TOP CABINET				FP1030A	S8001583	AC:120V	1-
	ALUMINUM TOP CABINET				FP1030A	S8001584	AC:230V	1-
	ALUMINUM TOP CABINET				FP1030A	S8001584	AC:240V	1-
	BRACKET (2pcs)				FP1030A	S8001585		1-
	PLATE (2pcs)				TYPE(I)	S8001586		1-
	PLATE (4pcs)				TYPE(L)	S8001587		1-
	POST (2pcs)				3X0.5X5.5X10M/M	S8001595		1-
	POST (2pcs)				5X10M/M	S8001596		1-
	FUSE HOLDER				JEF-609 BLK10A	S8001623	AC:100V	1-
	FUSE HOLDER				JEF-609 BLK10A	S8001623	AC:120V	1-
	FUSE HOLDER				FHB-02 BLK10A	S8001624	AC:230V	1-
	FUSE HOLDER				FHB-02 BLK10A	S8001624	AC:240V	1-
	SHEET				750MO 52X80M/M	S8001626		1-
	SHEET				33X41X0.8THK M/M	S8001627		1-
	SHEET (4pcs)				TO-3P3 THK 0.1M/M	S8001628		1-
	SILICON RUBBER (2pcs)				TO-220 THK 0.3M/M	S8001629		1-
	BUSH				TO-3B 3.3M/M THK	S8001630		1-
	BUSH (2pcs)				TO-220 1.8M/M THK	S8001631		1-
	BUSH				SRB-F-4	S8001632	AC:100V	1-
	BUSH				SRB-R-6	S8001633	AC:120V	1-
	BUSH				SRB-R-6	S8001633	AC:230V	1-
	BUSH				SRB-R-6	S8001633	AC:240V	1-
	PLASTIC TIE				L=5 BLACK	S8001634		1-
	NYLON CLAMP (17pcs)				PLT-1M BK-1	S3000022		1-
	FRONT PANEL ASS'Y					S8001645		1-
	with	FRONT PANEL						
		KNOB (RED, BLACK)						
		CIGGER SOCKET						
		FIBER WASHER						
		TERMINAL (RED, BLACK)						

# Mechanical Details (Exploded Views & Mechanical Parts)

Screw List		
No.	VXSTD P/N	Description Qty.
1	S8001598	SCREW M3X6X0.5 W/NL/BIND 2
2	S8001599	SCREW M3X6X0.5 W/BLACK 12
3	S8001600	SCREW M3X12X0.5 W/NL PAN 4
4	S8001601	SCREW M3X8X0.5 W/NL P.HED 11
5	S8001602	SCREW M3X15X0.5 W/NL P.HED 1
6	S8001603	SCREW M3X18X0.5 W/NL P.HED 2
7	-	-
8	S8001605	SCREW M4X10X0.7 W/NL P.HED 4
9	S8001606	TAPPING SCREW M2X7PA P.HED 2
10	S8001607	TAPPING SCREW M3X10PA P.HED 4
11	S8001608	TAPPING SCREW M3X6 PT P.HED 2
12	S8001609	TAPPING SCREW M3X8 PT P.HED 7
13	S8001615	FIBER WASHER M3X8X0.8 5
14	S8001619	EXT. TOOTH WASHER M3X6X0.9 FP1030A 13
15	-	-
16	S8001621	EXT. TOOTH WASHER M5X11.2 FP1030A 2
17	S8001597	SCREW M3X6X0.5 W/NL PAN 20
18	S8001611	WASHER M3X12X1 FP1030A 4
19	S8001612	WASHER M3X12X1 FP1030A 4
20	S8001613	WASHER M4X14X1 FP1030A 4
21	S8001616	SPRING WASHER M3X5X0.7 17
22	S8001617	SPRING WASHER M4X7X1 4
23	S8001618	SPRING WASHER M5X9X1.4 2
24	S8001622	NUT M5X0.8 F/FP1030A 4
25	U60300302	NUT M3 1

