

Package: S-20

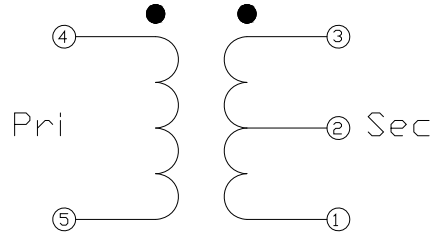
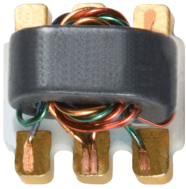

Schematic

Features

- Frequency Range .4MHz to 500MHz
- Low Cost and RoHS Compliant
- Industry Standard SMT package
- Available in Tape-and-Reel
- 50Ω Characteristic Impedance
- Flux Coupled

Applications

- Broadband/CATV
- Wireless

Product Description

The RFXF3513 transformer is designed for applications that require very small, low cost, and highly reliable surface mount components. Applications may be found in broadband, wireless, and other communications systems. These units are built Lead-Free and RoHS compliant. S-Parameters are available on request.

Parameter	Specification			Unit	Condition
	Min.	Typ.	Max.		
Overall					Typical values represent Mid-Band performance at 25 °C
Frequency Range	.4		500	MHz	
Insertion Loss < 1dB	1		100	MHz	
Insertion Loss < 2dB	.5		300	MHz	
Insertion Loss < 3dB	.4		500	MHz	
Amplitude Balance 1MHz to 100MHz		0.02	0.1	dB	
Amplitude Balance .5MHz to 300MHz		0.2	0.6	dB	
Amplitude Balance .4MHz to 500MHz		0.5	2.0	dB	
Phase Balance 1MHz to 100MHz		1	2	°	Nominal Phase Difference is 180°
Phase Balance .4MHz to 500MHz		2	5	°	Nominal Phase Difference is 180°
Impedance Ratio, P:S	1:1				
Type - Flux Coupled	Unbalance to Balanced				

Absolute Maximum Ratings

Parameter	Rating	Unit
RF Power	2	W
Operating Temperature	-45 to +85	°C
Storage Temperature	-55 to +100	°C



Caution! ESD sensitive device.

Exceeding any one or a combination of the Absolute Maximum Rating conditions may cause permanent damage to the device. Extended application of Absolute Maximum Rating conditions to the device may reduce device reliability. Specified typical performance or functional operation of the device under Absolute Maximum Rating conditions is not implied.

The information in this publication is believed to be accurate and reliable. However, no responsibility is assumed by MiniRF, Inc. ("MiniRF") for its use, nor for any infringement of patents, or other rights of third parties, resulting from its use. No license is granted by implication or otherwise under any patent or patent rights of MiniRF. MiniRF reserves the right to change component circuitry, recommended application circuitry and specifications at any time without prior notice.



RoHS (Restriction of Hazardous Substances): Compliant per EU Directive 2002/95/EC.

Input Return Loss

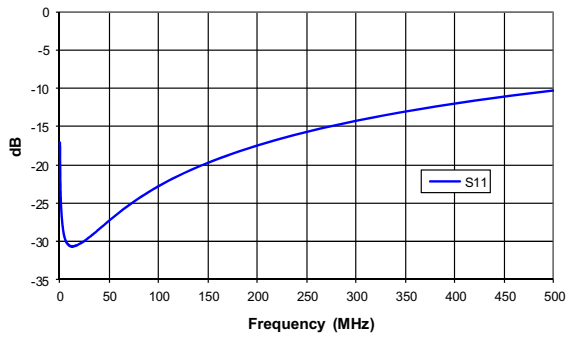

Insertion Loss

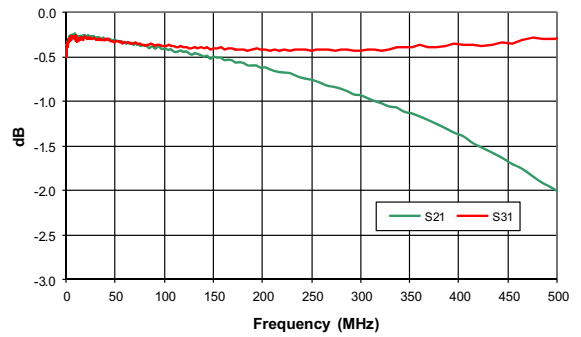

Amplitude Balance

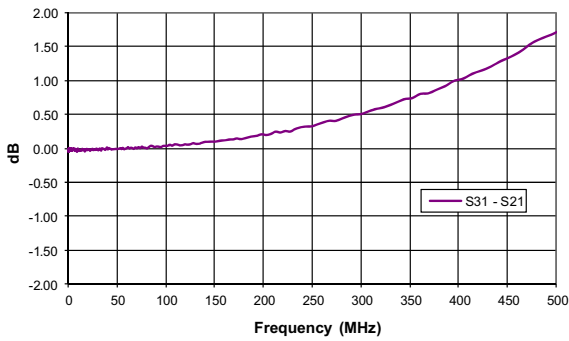

Phase Balance

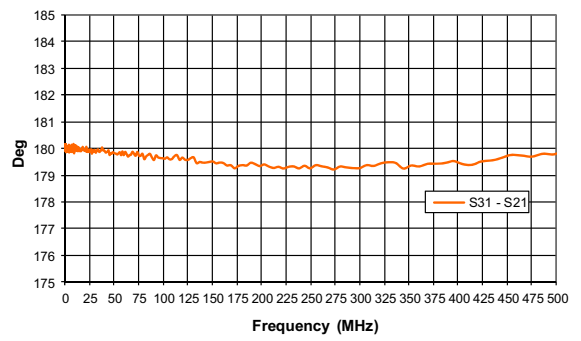

Pin Names and Description

Pin	Function	Description
1	Secondary	Output 2.
2	Secondary CT	Ground.
3	Secondary Dot	Output 1.
4	Primary Dot	Input.
5	Primary	Ground.

Package Drawing - S20

Dimensions in inches (millimeters)

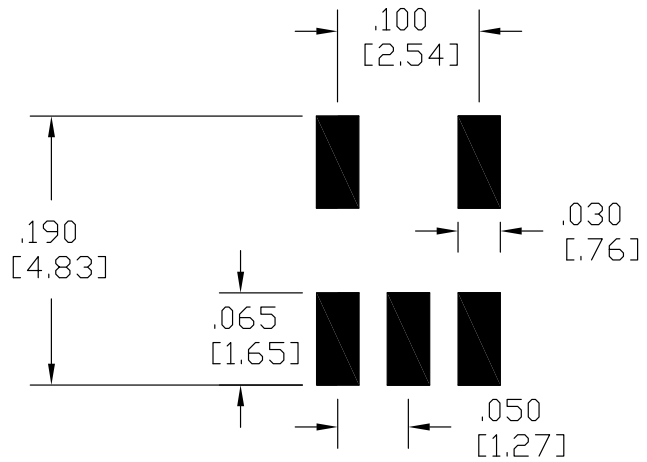
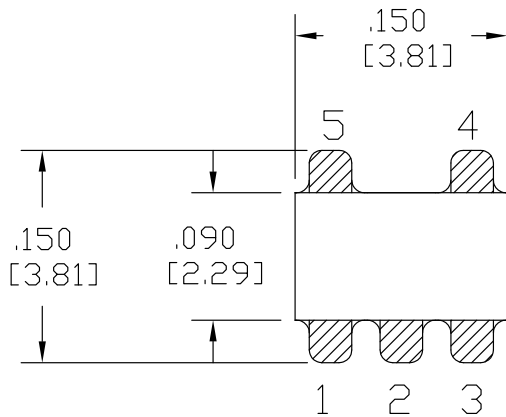

PCB FOOTPRINT

